

# Ultrasonic distance measuring sensors

## UNDK 20U6912/S35A

### dimension drawing

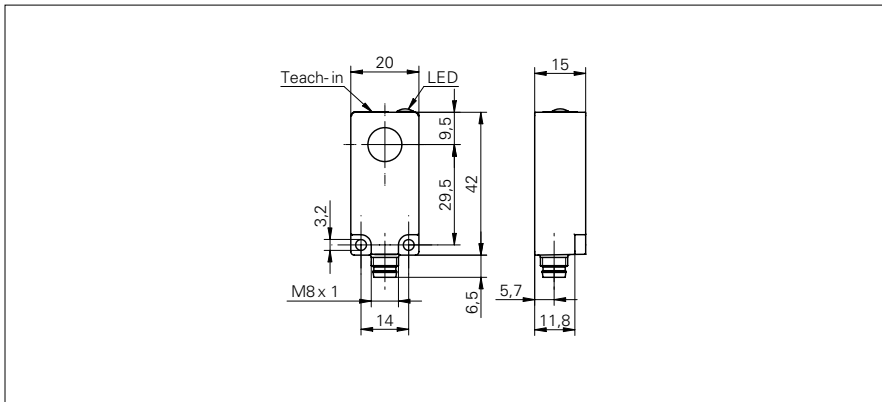

### general data

scanning range sd	60 ... 400 mm
scanning range close limit Sdc	60 ... 400 mm
scanning range far limit Sde	60 ... 400 mm
repeat accuracy	< 0,5 mm
resolution	< 0,3 mm
response time ton	< 60 ms
release time toff	< 60 ms
temperature drift	< 2 % of distance to target So
sonic frequency	290 kHz
adjustment	Teach-in
alignment aid	target indication flashing
light indicator	yellow LED / red LED

### electrical data

voltage supply range +Vs	15 ... 30 VDC
current consumption max. (no load)	35 mA
output circuit	voltage output
output signal	0 ... 10 V / 10 ... 0 V
output current	< 20 mA
residual ripple	< 10 % Vs
short circuit protection	yes
reverse polarity protection	yes

### mechanical data

type	rectangular
housing material	polyester
width / diameter	20 mm
height / length	42 mm
depth	15 mm
connection types	connector M8

### ambient conditions

operating temperature	-10 ... +60 °C
protection class	IP 67

### photo



### connection diagram

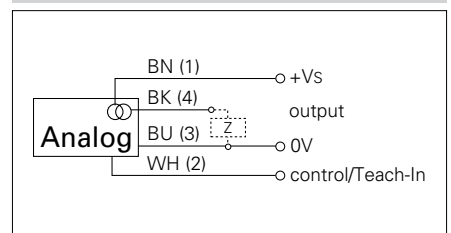

- internal and external Teach-in
- compact housing